

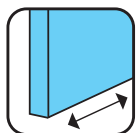

Sistemas para Portas de Correr
Portas em vidro



SOFTPRO[®]
TECHNOLOGY by Saheco

Multiplo Compact Glass

SV-T-PRO X110
(Telescópica)
110Kg

Multiplo Compact Glass 110

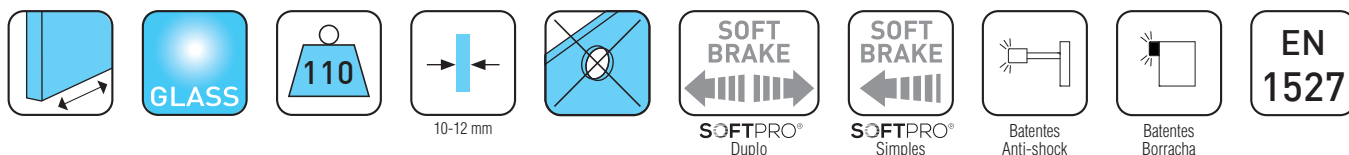

Multiplo Compact Glass SV-T-PRO X110 é uma solução compacta de portas de correr em vidro suspensas, com **movimento telescópico progressivo**, que oculta todos os mecanismos no perfil superior e minimiza o espaço entre a folha e a parede, apresentando um design com concepção minimalista, atraente e fácil de instalar.

Não necessita de mecanizar o vidro.

Sistema permite colocar 2 folhas de vidro de grandes dimensões com largura até 1600mm / 110Kg por folha, permitindo a abertura de grandes espaços de forma elegante e sofisticada.

Existe a possibilidade de optar por anti-shock, batente ou silenciosa tecnologia proporcionada pelo sistema **SOFTPRO** (travão amortecedor) simples ou duplo que acompanha suavemente a porta no final do percurso (abertura-fecho).

Opção, com o mesmo perfil, de instalação ao tecto ou com tecto falso, o que permite ocultar completamente o mecanismo no tecto, simulando assim, o movimento de paredes em vidro. Solução também para aplicação conjugada com vidro fixo.

Disponibilizam-se outros sistemas para portas de correr em vidro de 40 até 300Kg por folha.

Mais informações em: www.batista-gomes.pt

Opções de instalação

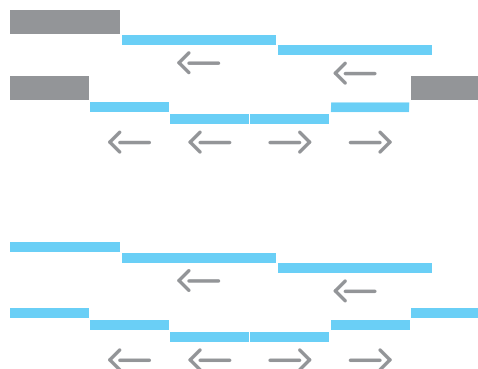

Sistema com tecnologia de amortecimento **SOFTPRO Duplo** para os 2 lados.



CERTIFICADO DE QUALIDADE	Detalhes		
Categorias	Durabilidade 6	Peso da Porta 110Kg	Tipo de porta Vidro
Durabilidade	100.000 ciclos		
Corrosão	Grau 3 Adequado para ambiente húmidos		



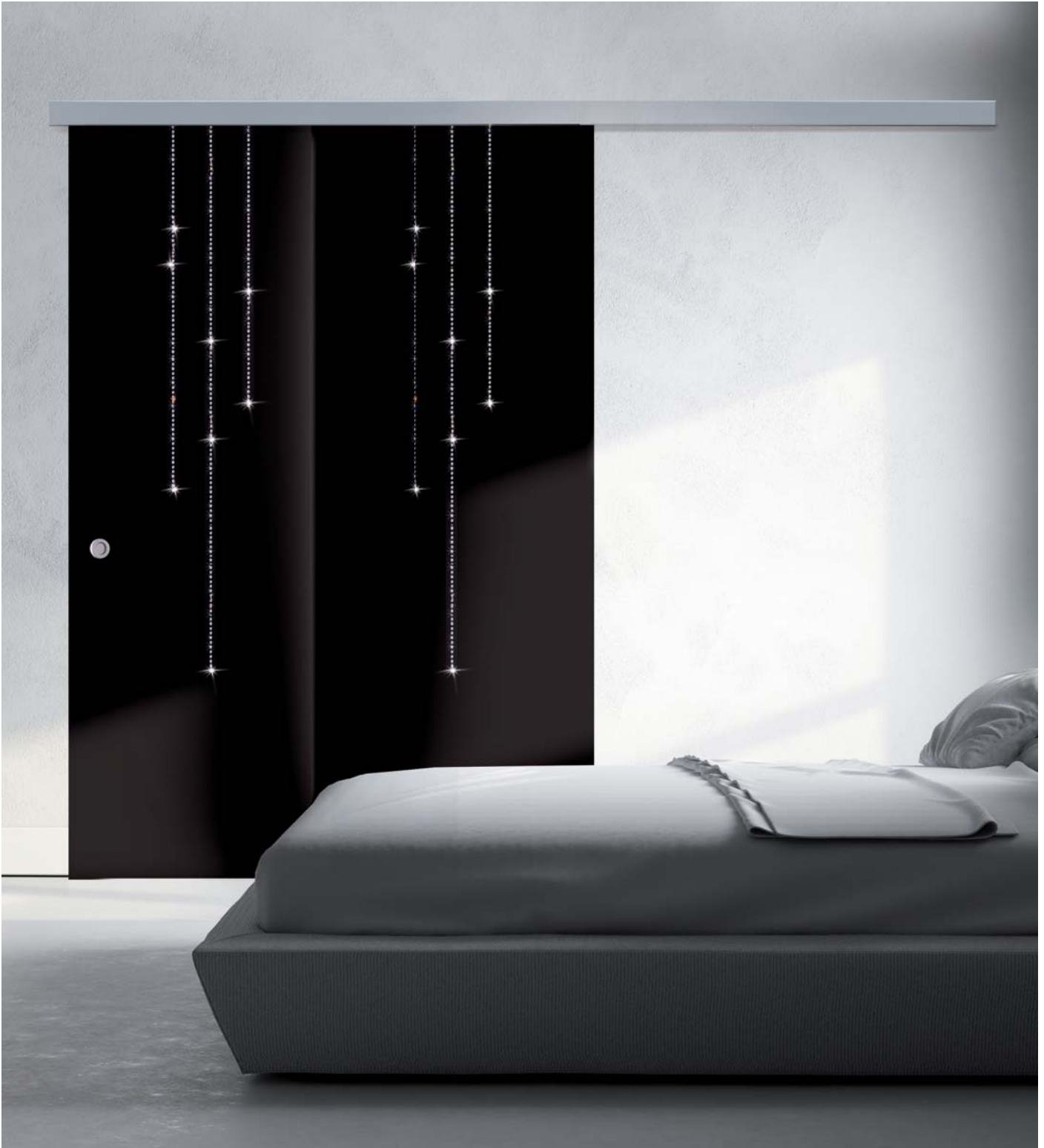

SOFTPRO®
TECHNOLOGY by Saheco

SOFT BRAKE

Tecnologia de fecho suave SOFTPRO®

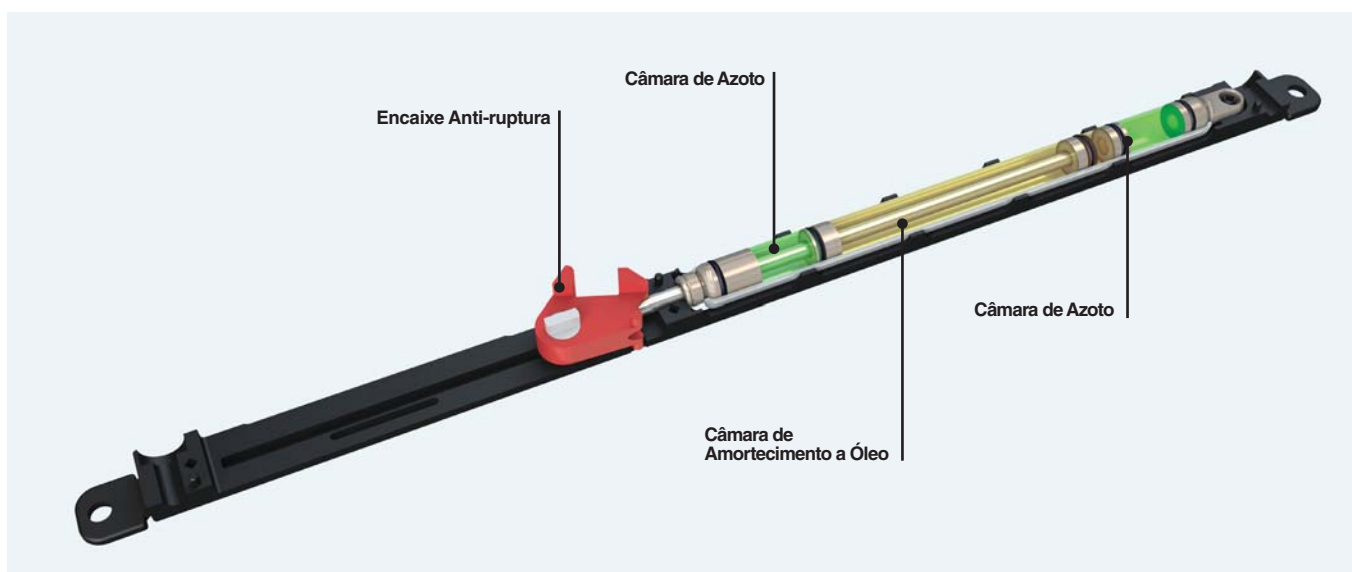

A nova tecnologia de amortecedor **SOFTPRO**® combina a função de fecho suave com duas câmaras a gás e um amortecedor a óleo, num único componente.

CARACTERÍSTICAS SOFTPRO®

Proporciona um movimento harmonioso com amortização fiável e segura.

Amortização progressiva da velocidade nos últimos 65mm, para portas até 110kg.

Dispõe de 4 funções diferentes:

- Velocidade de fecho ajustável;
- Fecho progressivo, ficando mais lento quando a porta se aproxima do golpe final;
- Fecho suave;
- Encaixe resistente ao desgaste.

Garante um fecho seguro, evitando o retroceder da porta.

Sistema Roldanas SV-T-PRO X110 com SOFTPRO®



SOFTPRO[®] TECHNOLOGY by Saheco
SOFT BRAKE

Tecnologia de fecho suave **SOFTPRO**[®]
Para os 2 lados



Sistema Roldanas SV-T-PRO X110

2 Anti-Shock



2 Batentes Borracha



Perfis

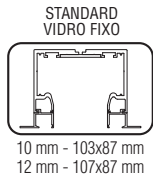
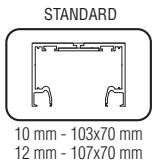

Especificações

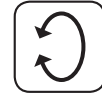
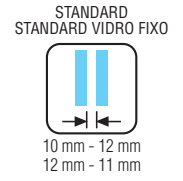
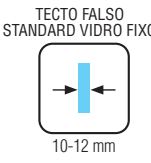
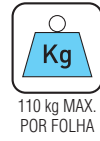

CERTIFICADO DE QUALIDADE	Detalhes		
Categorias	Durabilidade 6	Peso da Porta 110Kg	Tipo de porta Vidro
Durabilidade	100.000 ciclos		
Corrosão	Grau 3 Adequado para ambientes húmidos		



Acessórios

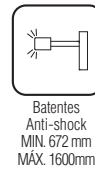
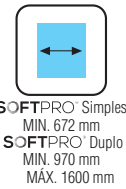
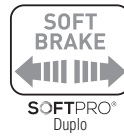

Opções de instalações

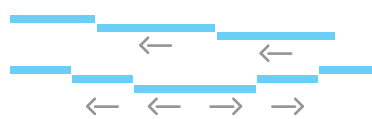
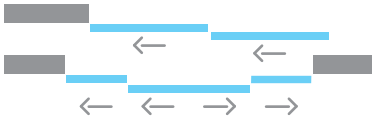

SV - T-PRO X110 INSTALAÇÃO NO TECTO

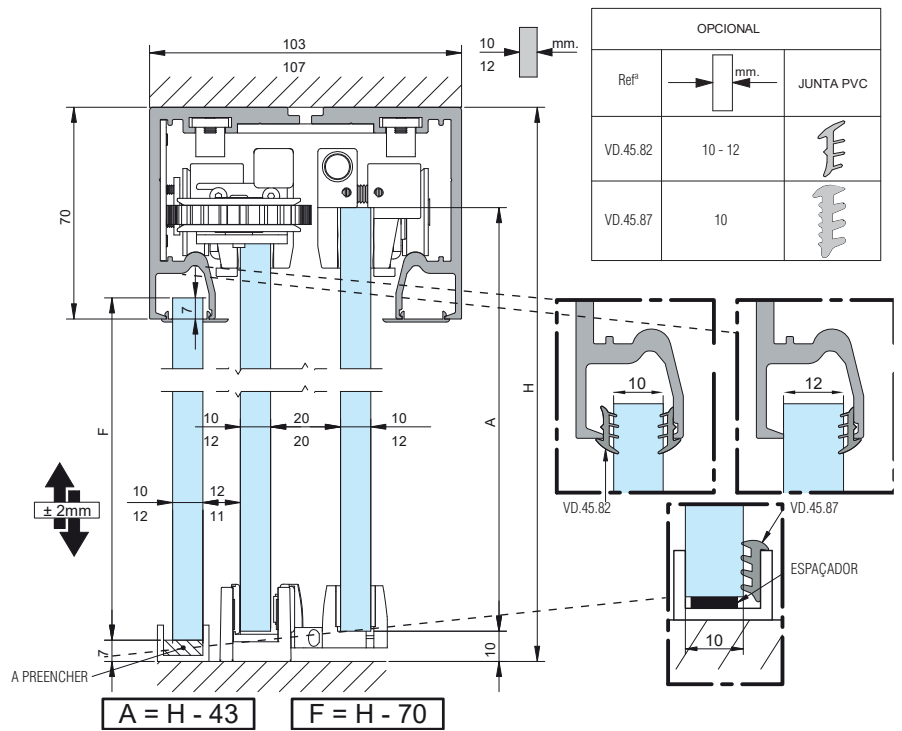
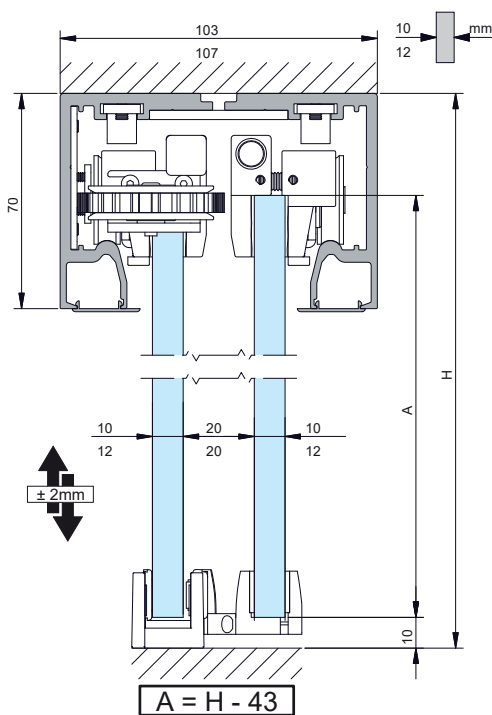

SV - T-PRO X110 INSTALAÇÃO EM TECTO FALSO

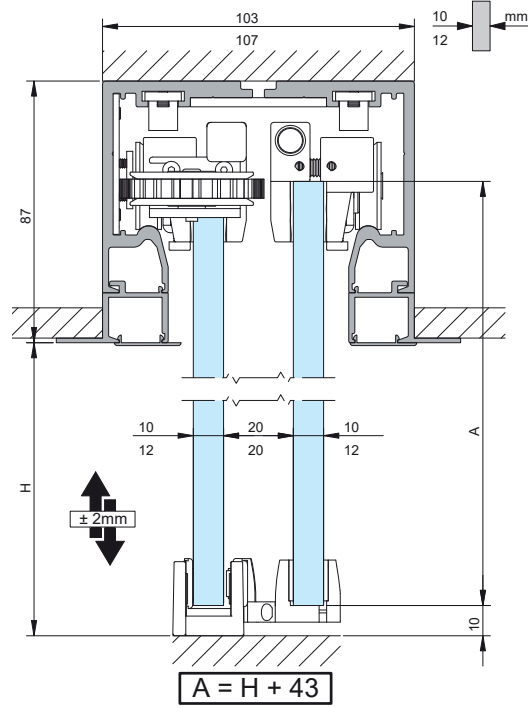

SV - T-PRO X110 INSTALAÇÃO EM TECTO FALSO

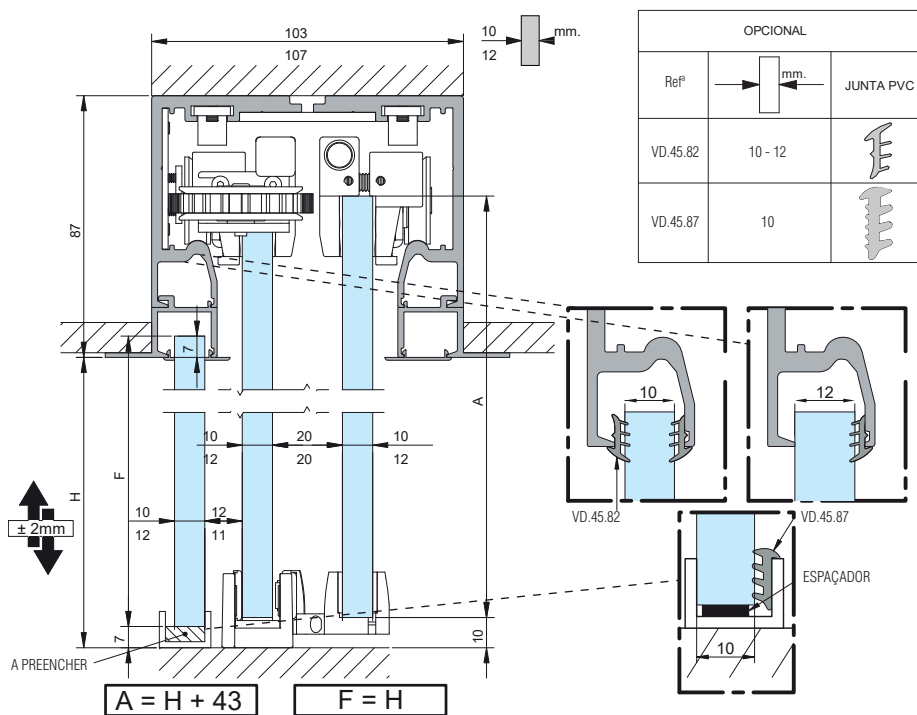

Sistemas de montagem

SV - T-PRO X110

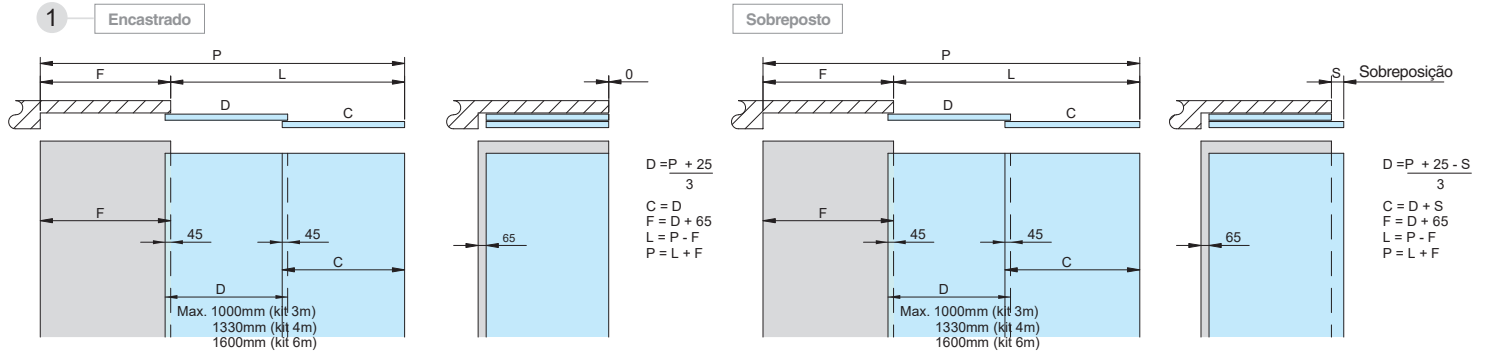

SV - T-PRO X110 INSTALAÇÃO DAS PINÇAS

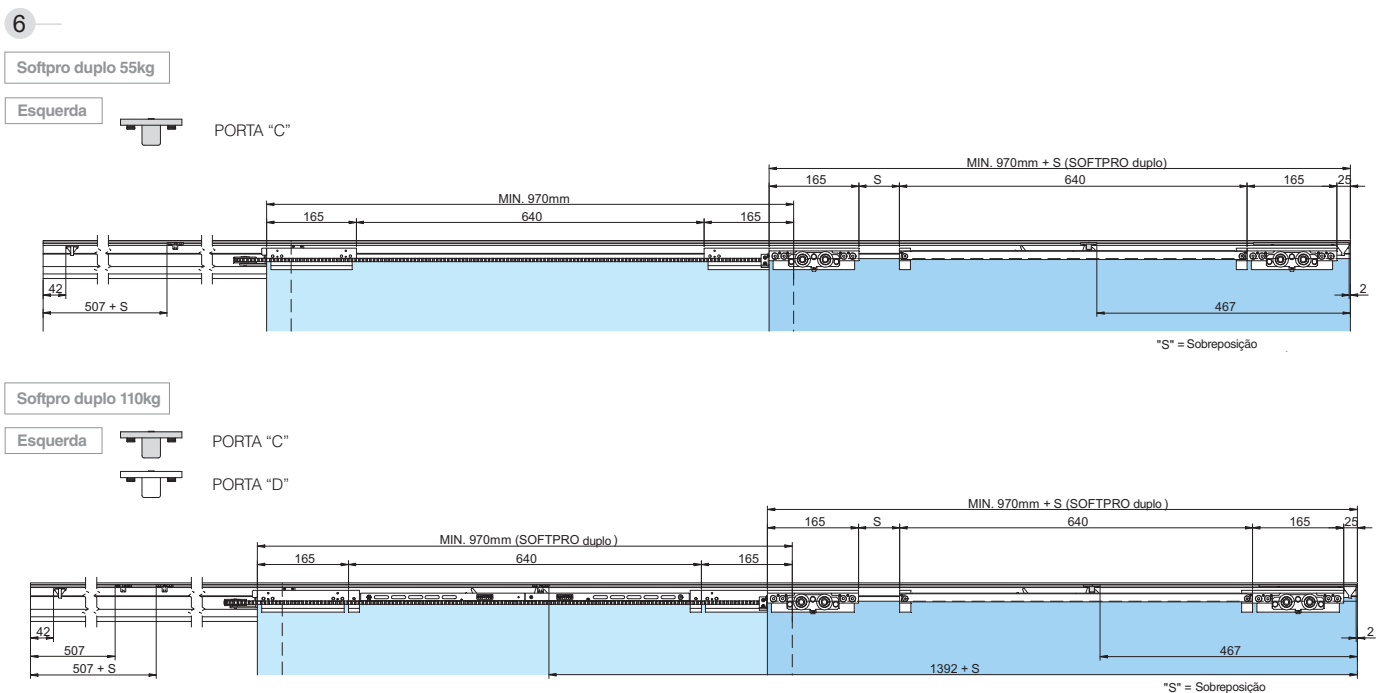
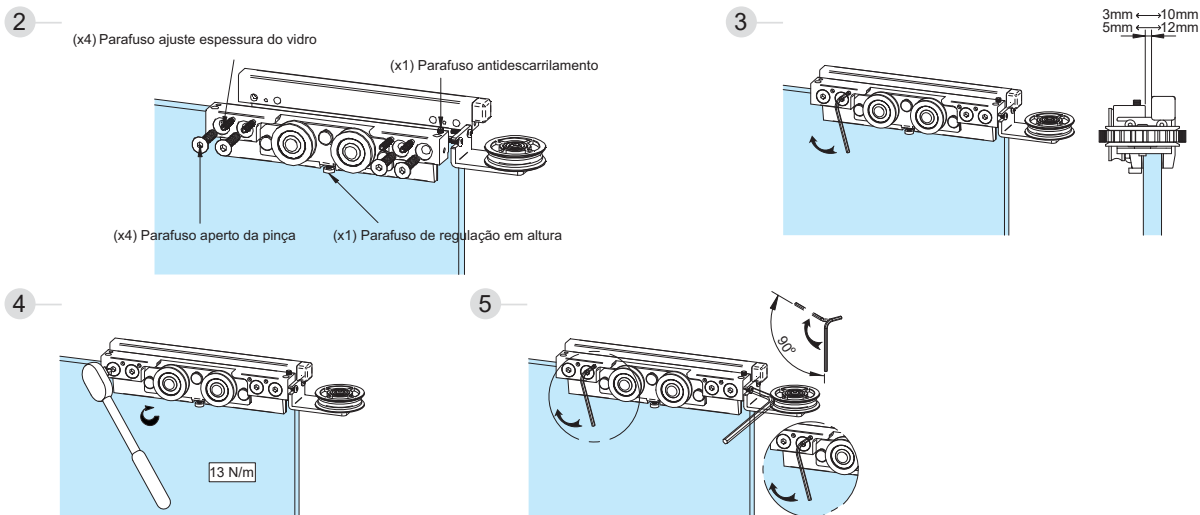

Sistemas de montagem

SV - T-PRO X110 INSTALAÇÃO DAS PINÇAS

Softpro simples 55kg + Anti-shock

Esquerda



PORTA "C"

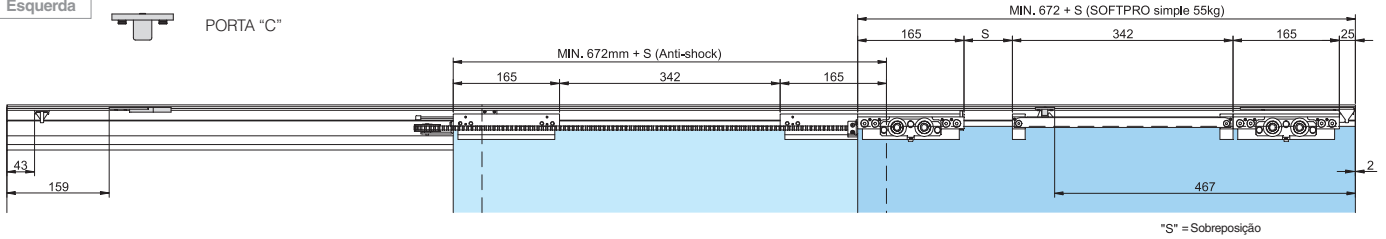

Softpro simples 110kg + Anti-shock

Esquerda



PORTA "C"



PORTA "D"

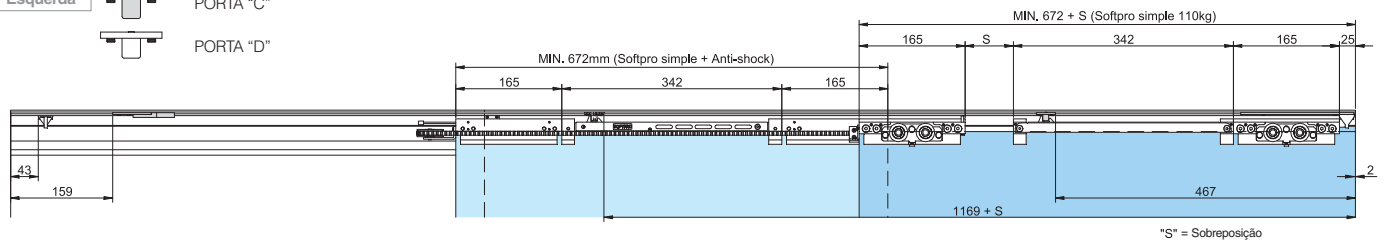

Batentes de borracha

Esquerda

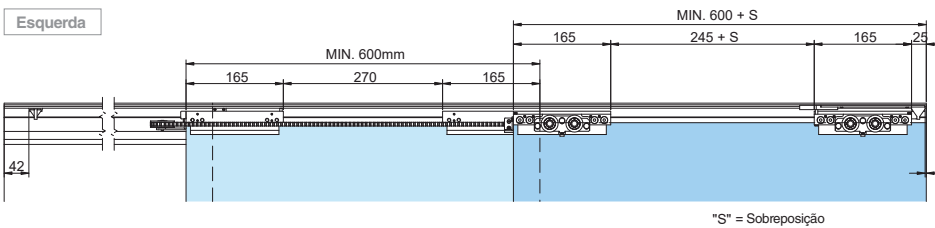

SV - T-PRO X110 MEDIDA DA CORREIA

7

MEDIDA DA CORREIA
2 x (D + 140 mm)

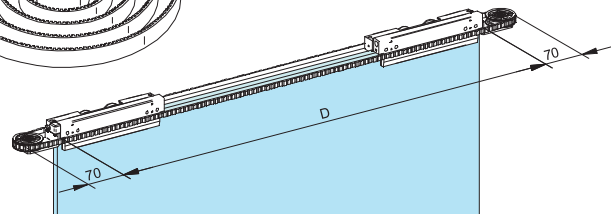
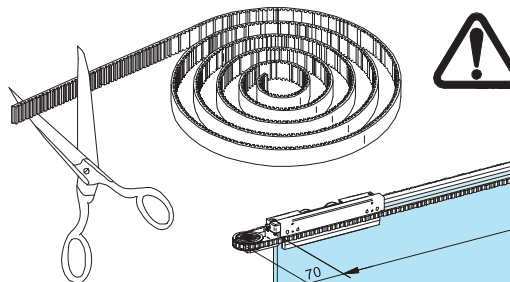
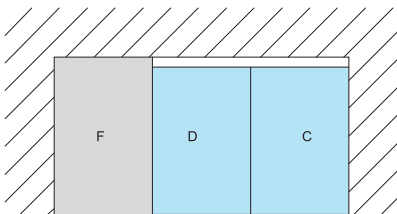

8

Esquerda

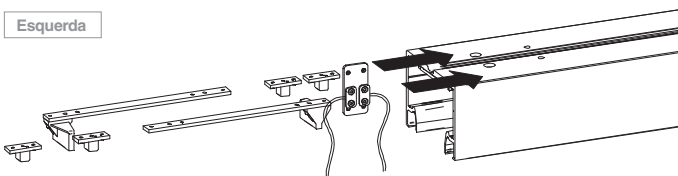

Sistemas de montagem

SV - T-PRO X110 MONTAGEM DAS PORTAS

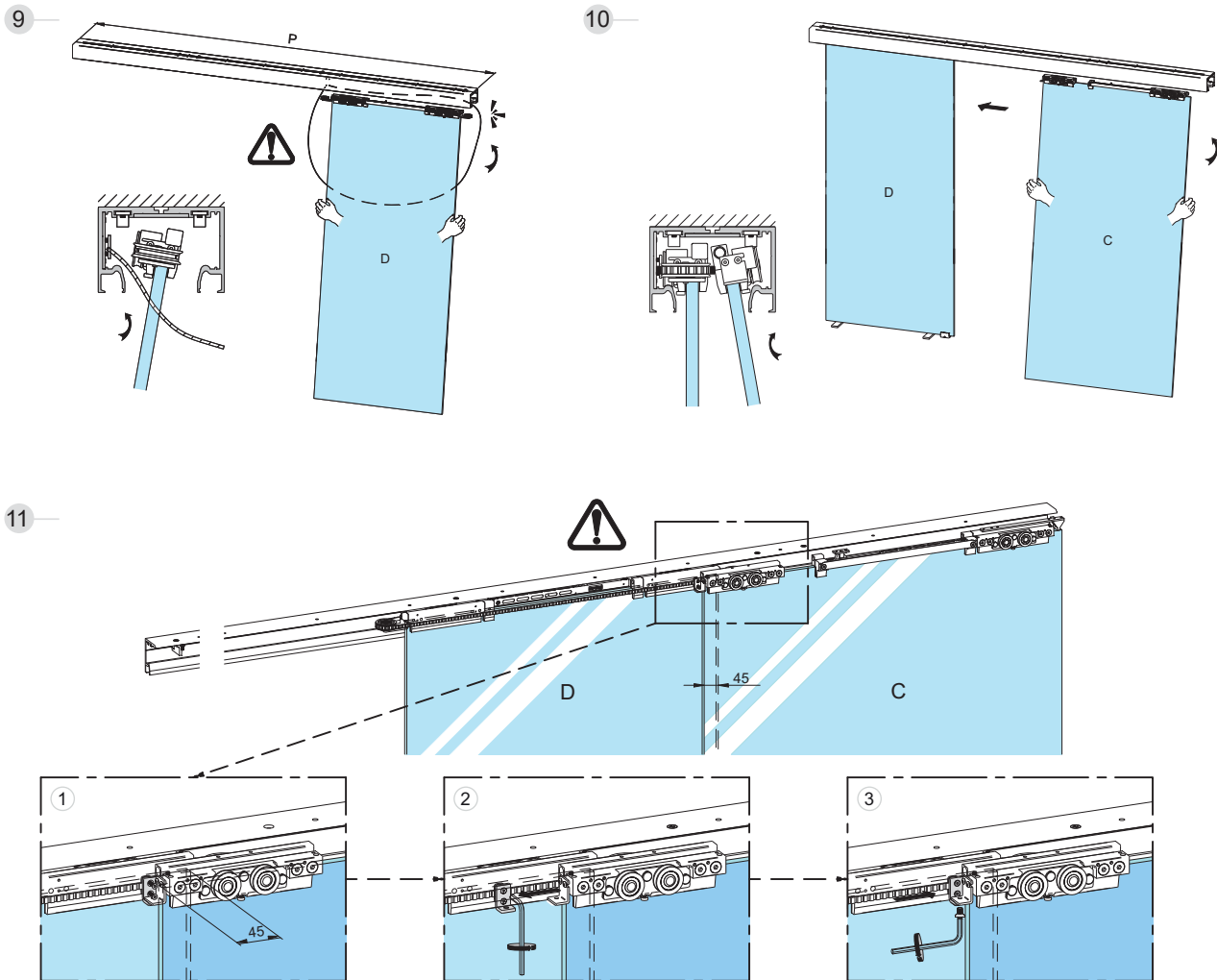

SV - T-PRO X110 MONTAGEM GUIAS INFERIORES

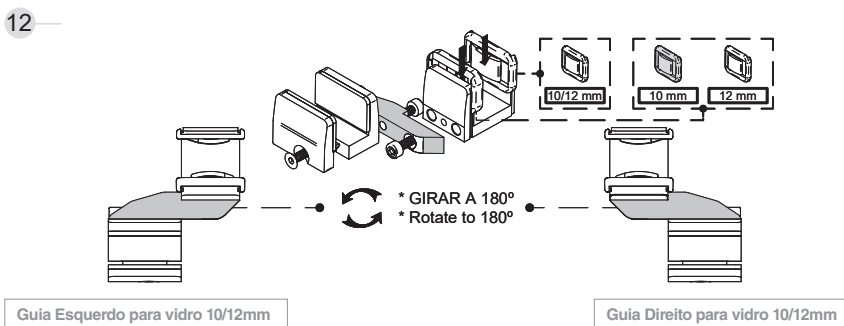

SV-T-PRO X110	REF.	DIM.	ACB	DESCRIÇÃO	
KITS PARA PORTAS DE CORRER + FOLHA FIXA					
 ROLAMENTO DE ESFERAS	KIT. SV-910.41 	3m 	AAN	KIT SV-T-PRO X110 2 BATENTES Espessura vidro 10mm KIT completo de perfis + acessórios para 2 portas Telescópicas Progressivas Aplicação no tecto ou tecto falso Com ou sem folha fixa Largura da folha: 600 a 1600mm 	1
	KIT. SV-910.43 	4m 	AAI*		
 ROLAMENTO DE ESFERAS	KIT. SV-910.49 	3m 	AAN	KIT SV-T-PRO X110 2 BATENTES Espessura vidro 12mm KIT completo de perfis + acessórios para 2 portas Telescópicas Progressivas Aplicação no tecto ou tecto falso Com ou sem folha fixa Largura da folha: 600 a 1600mm 	1
	KIT. SV-910.51 	4m 	AAI*		
 ROLAMENTO DE ESFERAS SOFTPRO	KIT. SV-109.58 	3m 	AAN	KIT SV-T-PRO X110 SOFTPRO SIMPLES + ANTI-SHOCK Espessura vidro 10mm KIT completo de perfis + acessórios para 2 portas Telescópicas Progressivas Aplicação no tecto ou tecto falso Com ou sem folha fixa Largura da folha: 672 a 1600mm 	1
	KIT. SV-109.80 	4m 	AAI*		
 ROLAMENTO DE ESFERAS SOFTPRO	KIT. SV-109.82 	3m 	AAN	KIT SV-T-PRO X110 SOFTPRO SIMPLES + ANTI-SHOCK Espessura vidro 12mm KIT completo de perfis + acessórios para 2 portas Telescópicas Progressivas Aplicação no tecto ou tecto falso Com ou sem folha fixa Largura da folha: 672 a 1600mm 	1
	KIT. SV-109.84 	4m 	AAI*		

SV-T-PRO X110	REF.	DIM.	ACB	DESCRIÇÃO	
KITS PARA PORTAS DE CORRER + FOLHA FIXA					
 	KIT. SV-910.65	3m	AAN	KIT SV-T-PRO X110 SOFTPRO DUPLO Espessura vidro 10mm KIT completo de perfis + acessórios para 2 portas Telescópicas Progressivas Aplicação no tecto ou tecto falso Com ou sem folha fixa Largura da folha: 970 a 1600mm 	1
	KIT. SV-910.67	4m			
 	KIT. SV-910.69	3m	AAN	KIT SV-T-PRO X110 SOFTPRO DUPLO Espessura vidro 12mm KIT completo de perfis + acessórios para 2 portas Telescópicas Progressivas Aplicação no tecto ou tecto falso Com ou sem folha fixa Largura da folha: 970 a 1600mm 	1
	KIT. SV-910.71	4m			
 VD.45.82 VD.45.87	VD.45.82 Vidro 12mm VD.45.87 Vidro 10mm	1m 1m	Transp.	Vedante PVC transparente Perfil para vidro 12mm Perfil para vidro 10mm	1

AAN - Alumínio Anodizado Natural (Prata Mate) / AAI - Alumínio Anodizado Inox / *AAI: Por consulta

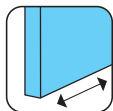

Duplo Glass

ADEQUADO PARA ARMÁRIOS
SV-45
SV-85



Até 45 / 85Kg por folha



Classic Glass

SV-A40 SV-A100
SV-A60 SV-A121
SV-A80 SV-A125
SV-LARGE SV-A200
SV-A300

Até 40 / ... / 300Kg por folha



Roller Glass

SV-ROLLER MINIMAL 80
SV-ROLLER EASY 80
COM SOFTBRAKE INTEGRADO



Até 80Kg por folha



Classic Glass EASY

SV-EASY 60
SV-EASY 80
SV-EASY LARGE



Até 80Kg por folha



Multiplo Glass

TELESCÓPICAS
SV-SINCRO 80/125
SV-T PROGRESSIVA 80
SV-T PROGRESSIVA SINCRO

Até 80 / 125Kg por folha



Compact Glass

SV-X70
SV-X110
SV-X150

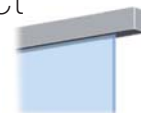

Até 70 / 80 / 150Kg por folha



Matic Glass

AUTOMÁTICAS
SV-MATIC
SV-MATIC SINCRO

Até 80Kg por folha



Inox Glass

304 INOX

SV-I45 / SV-I46
SV-I120
SV-I120 U Simples / U Duplo
SV-I240

Até 45 / 120 / 240Kg por folha



Parking Glass

SV-P40
SV-P150
SV-P250



Até 40 / 150 / 250Kg por folha



Plicat Glass

PORTAS ARTICULADAS
SV-A101D

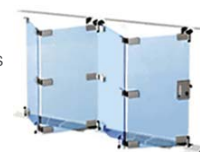

Até 100Kg por par de folhas



Shower Glass

SV-HYDRO GLASS
SV-X70 Compact Glass
SV-I GUIBLI / SV-145
SV-I120 U Simples / U Duplo

Até 45 / 60 / 80 / 120Kg por folha



Boxkel Mito

ESTRUTURAS PRÉ-MONTADAS

Parede: Reboco ou Pladur

Até 80Kg por folha

Acessórios FECHADURAS / PUXADORES / ASAS

Multiplo
Compact
Glass
SV-T-PRO X110

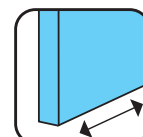

SV



BATISTA GOMES

P A R T N E R S



Batista Gomes, Lda.
Zona Industrial Sul
Variante Recardães-Barrô, 1541
P.O.Box 55
3754-001 Barrô-Águeda
Portugal

Tel: +351 234 612 520
Fax: +351 234 625 580
E-mail: geral@batista-gomes.pt

///BATISTA-GOMES.PT